

## 1 Introduction

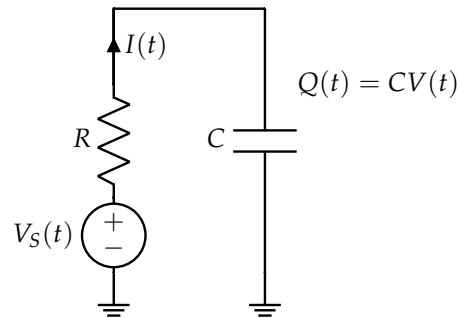

Figure 1: Capacitor charging through a circuit with a resistor.

In the previous note, we solved for the transient voltage  $V(t)$  on a capacitor charging up through a resistor, modeled by the following differential equation:

$$\frac{dV(t)}{dt} = -\frac{V(t)}{RC} + \frac{V_{DD}}{RC} \quad (1)$$

to get the solution  $\forall t \geq 0$ :

$$V(t) = V_{DD} \left(1 - e^{-\frac{t}{RC}}\right). \quad (2)$$

We had viewed the "input" as coming from switches reconfiguring themselves. When switches changed from one state to another, what held steady across that instantaneous switch was the charge (and hence voltage) on the capacitors. The previous configuration's end state provided the initial state for the next configuration. Alternatively, we can think of the voltage that we used to charge up the capacitor itself as an input to our circuit and allow that voltage  $V_S(t)$  to change with time. As far as the capacitor was concerned, it might as well have faced a piecewise constant input that had:

$$V_S(t) = \begin{cases} 0 & t < 0 \\ V_{DD} & t \geq 0 \end{cases} \quad (3)$$

Though we have only shown this for positive inputs ( $V_{DD} > 0$ ), it also applies to negative inputs such as  $-V_{DD}$ . Plugging in a negative input, we arrive at the following differential equation:

$$\frac{dV(t)}{dt} = -\frac{V(t)}{RC} - \frac{V_{DD}}{RC} \quad (4)$$

Using the same kind of change of variables, we can solve eq. (4) to get for  $t \geq 0$ ,

$$V(t) = -V_{DD} \left(1 - e^{-\frac{t}{RC}}\right) \quad (5)$$

while  $V(t) = 0$  for  $t < 0$ . This is the response of the circuit to inputs of the form:

$$V_S(t) = \begin{cases} 0 & t < 0 \\ -V_{DD} & t \geq 0 \end{cases} \quad (6)$$

Can we take what we know to build to understand more interesting inputs?<sup>1</sup>

<sup>1</sup>Sp22: you might be reminded here of the RC switching example in [Discussion 01B](#).

## 2 Time-Varying Piecewise Constant Inputs: Two Illustrative Cases

Having analyzed these basic cases, we want to consider how to deal with inputs that change over time in a more interesting fashion. We have a strategy that we think should work — treat piecewise constant inputs in the same way that we dealt with circuits with switches. Make the state (charge on the capacitor) be instantaneously constant across the configuration change, and solve the differential equation with that initial condition.

### Case 1: $V(t)$ On for a While, then Off

Let us start by considering the most basic changing input that we can think of: a voltage turning on to some value  $V_{DD}$  and then turning off.

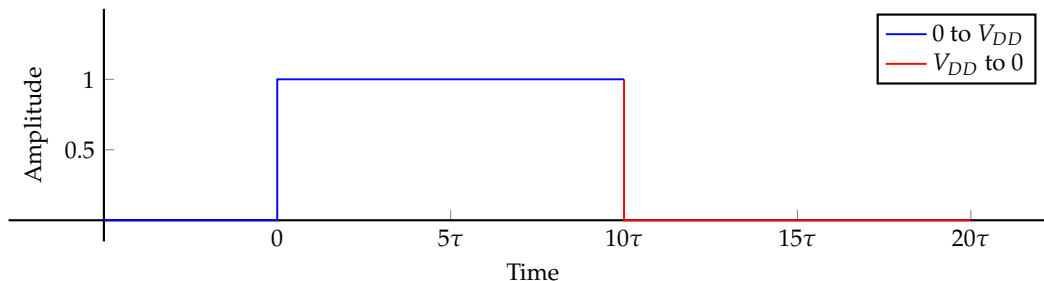

**Figure 2:** On and Off input: On for  $10\tau$ . Here  $\tau = RC$  is the time constant for the circuit.

As always, when analyzing these more complex problems, we try to phrase them in terms of problems that we already know how to solve. We can look at this case as a combination of two piecewise constant cases: A constant zero input held steady until some time  $T$ , which switches instantly to a steady constant 1 input until time  $T + D$  (here  $D$  is some constant representing how long we hold at  $V_{DD}$ ), falling back to zero again for the rest of time beyond  $T + D$ .

If  $D \gg \tau$  then the circuit has the opportunity to settle to steady-state in the "middle interval". We treat the circuit in 2 different time intervals; the first with initial condition at 0 and the second with initial condition at  $V_{DD}$  (in steady-state, this is the value that the circuit would settle to in the first interval, from  $T$  to  $T + D$ ).

Before we continue, let us establish some notation. We use  $V_i(t_{\text{int}})$  to denote the voltage on the capacitor during the  $i^{\text{th}}$  time interval that we are analyzing. Let  $t$  be absolute time starting at 0, and let  $t_{\text{int}}$  be the time from the beginning of the  $i^{\text{th}}$  interval until  $t$ . This time  $t_{\text{int}}$ , internal to the interval, is useful conceptually.<sup>2</sup>

**First Interval Analysis:** Analyzing the circuit for time  $t \in [0, 10\tau]$  with initial condition  $V(0) = 0$  and constant input  $V_{DD}$  starting at time  $t = 0$ , we get the differential equation in eq. (2) (where the initial condition is  $V(0) = 0$ ):

$$\frac{dV(t)}{dt} = -\frac{V(t)}{RC} + \frac{V_{DD}}{RC} \quad (7)$$

Recall the solution to this type of differential equation is:

$$V(t) = ke^{-\frac{t}{RC}} + V_{DD} \quad (8)$$

Here,  $k$  is some constant that we will solve for using initial conditions. Plugging in the initial condition, we get:

$$V(0) - V_{DD} = k \quad (9)$$

$$k = -V_{DD} \quad (10)$$

$$\implies V_1(t_{\text{int}}) = V(t) = V_{DD} \left(1 - e^{-\frac{t}{RC}}\right) \quad t \in [0, 10\tau] \quad (11)$$

<sup>2</sup>This notation might be a bit confusing initially, but reading the casework and analysis below will help clarify.

The solution to this differential equation is the same as the charging capacitor case! Since the input is held at  $V_{DD}$  until time  $10\tau$ , the circuit has time to settle to essentially steady-state. We can see this by plugging in  $t = 10\tau$ :

$$V(10\tau) = V_1(10\tau) = V_{DD} \left(1 - e^{-\frac{10\tau}{RC}}\right) \quad (12)$$

$$= V_{DD} \left(1 - e^{-10}\right) \quad (13)$$

$$\approx V_{DD}(1 - 0.00004539) \quad (14)$$

$$\approx V_{DD} \quad (15)$$

Thus, we have shown that by time  $t = 10\tau$ , the capacitor has approximately reached the steady-state voltage  $V_{DD}$ . We can now think about what happens for the next chunk of time ( $t \in [10\tau, 20\tau]$ ).

**Second Interval Analysis:** We now have a new initial condition:  $V(10\tau) = V_1(10\tau) = V_2(0) \approx V_{DD}$ .

Using this initial condition information, the definition  $t_{\text{int}} = t - 10\tau$ , and the steps above, we can solve for  $V_2(t_{\text{int}})$ :

$$\frac{dV(t)}{dt} = -\frac{V(t)}{RC} + 0 \quad (16)$$

Recall the solution to this type of differential equation is  $V(t) = ke^{-\frac{t}{RC}}$ . Plugging in the initial condition, we get  $V_2(t_{\text{int}}) = V_{DD} \left(e^{-\frac{t_{\text{int}}}{RC}}\right)$ . And so  $V(t) = V_{DD} \left(e^{-\frac{t-10\tau}{RC}}\right)$  for  $t \in [10\tau, 20\tau]$ . Here, we also see that  $10\tau$  after the input switch, the voltage  $V(t)$  again reaches steady-state:

$$V(20\tau) = V_2(10\tau) = V_{DD} \left(e^{-\frac{20\tau-10\tau}{RC}}\right) \quad (17)$$

$$= V_{DD} \left(e^{-10}\right) \quad (18)$$

$$\approx V_{DD}(0.00004539) \quad (19)$$

$$\approx 0. \quad (20)$$

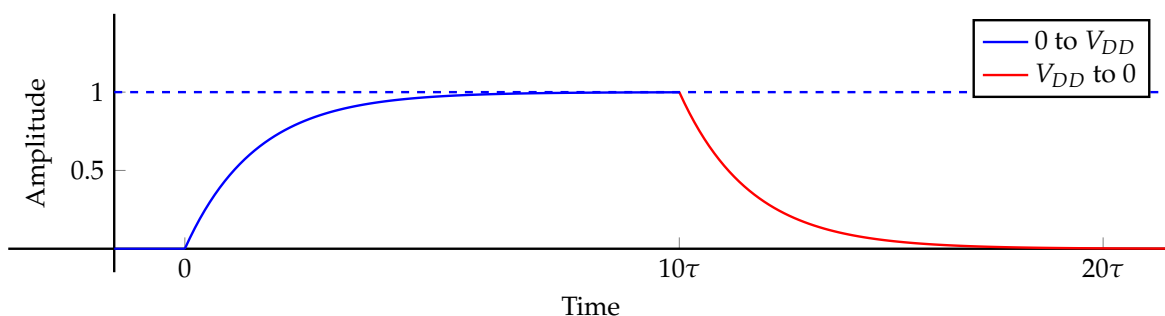
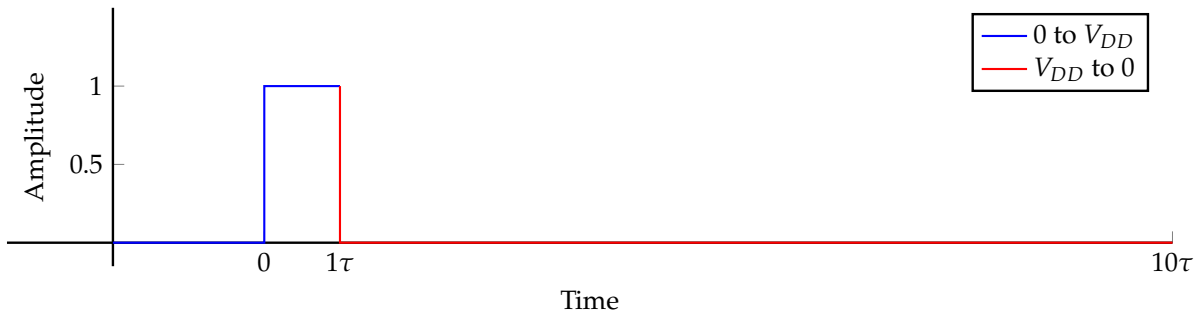

**Figure 3:**  $V(t)$  for On and Off input: On for  $10\tau$  and then off

We can summarize the results we have just derived in fig. 3. This is one kind of behavior — when the transients are isolated from each other (because the time period is long and allows the circuit's response to the previous piecewise input to reach steady-state). However there is also the case when the duration  $D < \tau$  (or  $D$  is not too much greater than  $\tau$ ). In such a case our circuit does not have the opportunity to settle into steady-state before the input changes. In such a case, we would need to calculate the exact voltage at the time our input changes to a 0 so that we could use an accurate initial condition for the second interval.

### Case 2: $V(t)$ On for not so long, then Off

Consider the case illustrated in fig. 4 where the input is only  $V_{DD}$  for a duration of one  $\tau = RC$  time constant.



**Figure 4:** On and Off input: On for  $1\tau$

Since the conditions for time  $t \in [0, 1\tau]$  are the same as the case before we end up with the same equation for  $V_1(t)$ :

$$V_1(t_{\text{int}}) = V(t) = V_{DD} \left(1 - e^{-\frac{t}{RC}}\right) \quad t \in [0, 1\tau] \quad (21)$$

However, since the input  $V_{DD}$  is now only held for  $1\tau$ , the circuit does not get a chance to reach steady-state before transitioning to the next stage when the input shifts from  $V_{DD}$  to 0.

$$V(1\tau) = V_{DD} \left(1 - e^{-1}\right) \quad (22)$$

$$\approx V_{DD}(1 - 0.36787) \quad (23)$$

$$\not\approx V_{DD}. \quad (24)$$

So, we can no longer use  $V_{DD}$  as our initial condition. Instead, we have to now explicitly calculate our initial condition by solving for  $V_1(t_{\text{int}})$  in the first time interval. As defined above, let the function for the voltage in the second interval be  $V_2(t)$  such that  $V_2(t_{\text{int}}) = V(t)$  for  $t \in [1\tau, 10\tau]$ , where  $t_{\text{int}} = t - 1\tau$ . Having solved for  $V_1(1\tau)$  we now have a new initial condition:  $V(1\tau) = V_2(0) = V_{DD}(0.63212)$ .

Solving the differential equation for the second interval and plugging in our initial condition, we get:

$$V_2(t_{\text{int}}) = V_{DD} \cdot 0.63212 \left(e^{-\frac{t_{\text{int}}}{RC}}\right) \quad (25)$$

in terms of time interval to that interval. In terms of absolute time:

$$V(t) = V_{DD} \cdot 0.63212 \left(e^{-\frac{t-1\tau}{RC}}\right) \quad t \in [1\tau, 10\tau]$$

This is illustrated in fig. 5.

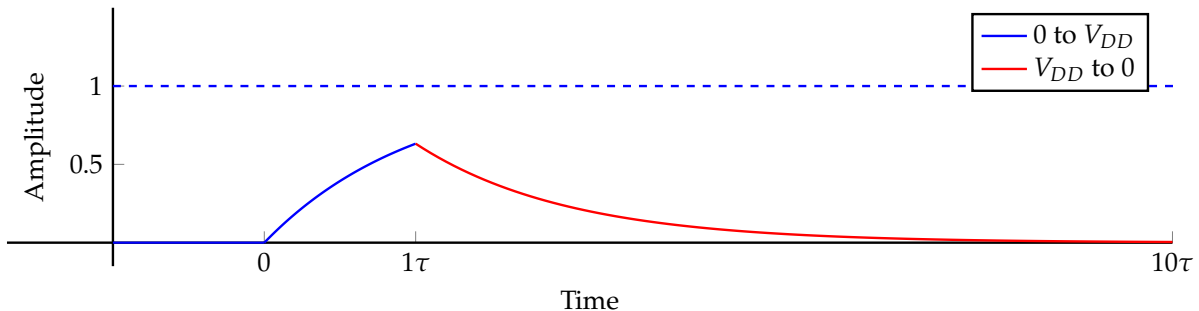
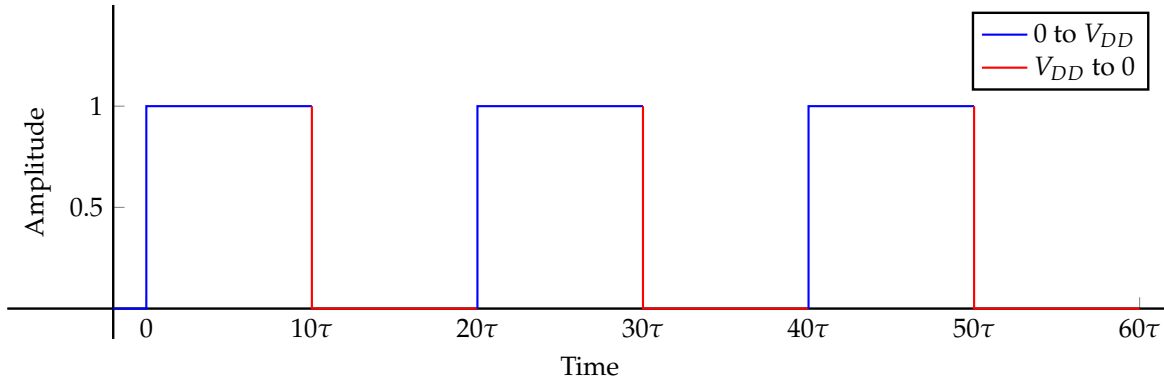

**Figure 5:**  $V(t)$  for On and Off input: On for  $1\tau$ , Off afterwards.

## 2.1 More Examples and Cases

At this point, we can use what we know to analyze and understand many different examples.

### 2.2 Case 1: Input is at 0 and then $V_{DD}$ Long Enough to Reach Steady State



**Figure 6:** Case 1 Input: Input where both states reach steady state

The first case to consider is when our repeated time varying input is held at  $V_{DD}$  and then held at 0 long enough to reach steady state in both directions. This is illustrated in fig. 6. The output voltage is illustrated in fig. 7.

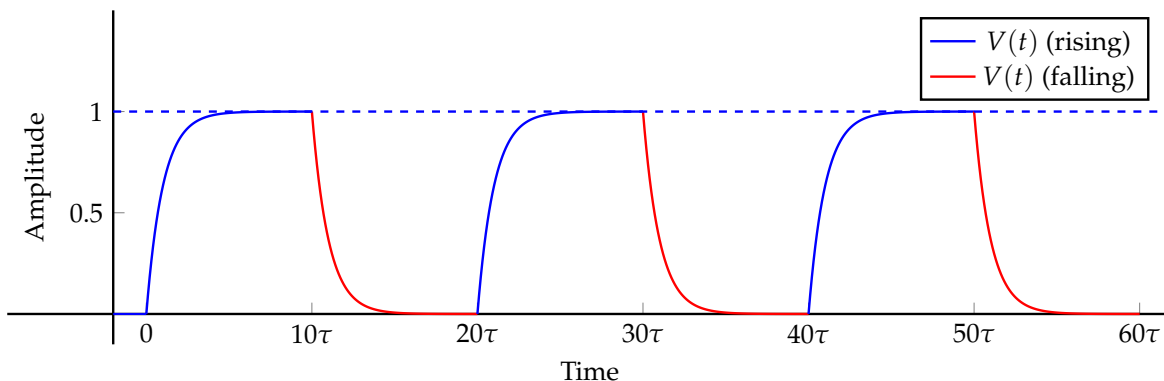

**Figure 7:** Case 1 Output: Transient voltage for repeated switching when both directions reach steady state.

### 2.3 Case 2: Input is at 0 Long Enough to Settle, and Does Not Settle at $V_{DD}$

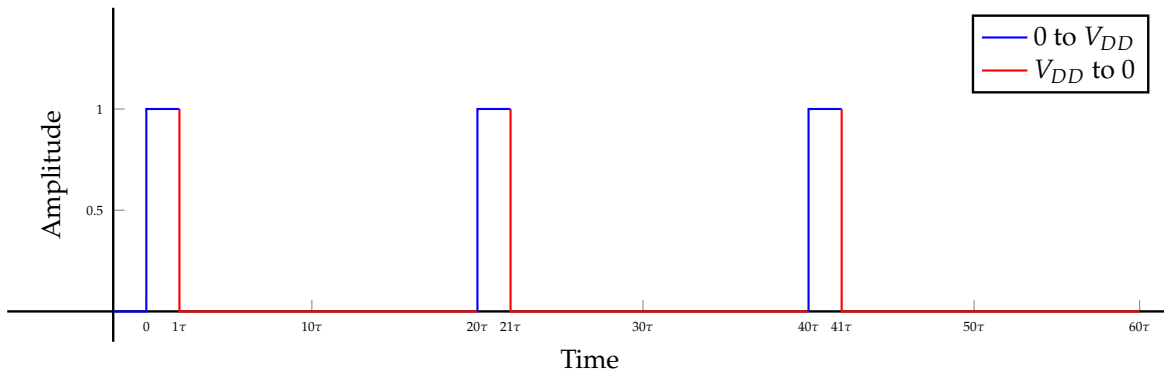

**Figure 8:** Case 2 Input: Input where the state settles only at 0.

The second case to consider is when our repeated time varying input is at 0 long enough to reach steady state but not at  $V_{DD}$  long enough to do so (or vice versa). This input is illustrated in fig. 8. The corresponding output voltage is illustrated in fig. 9.

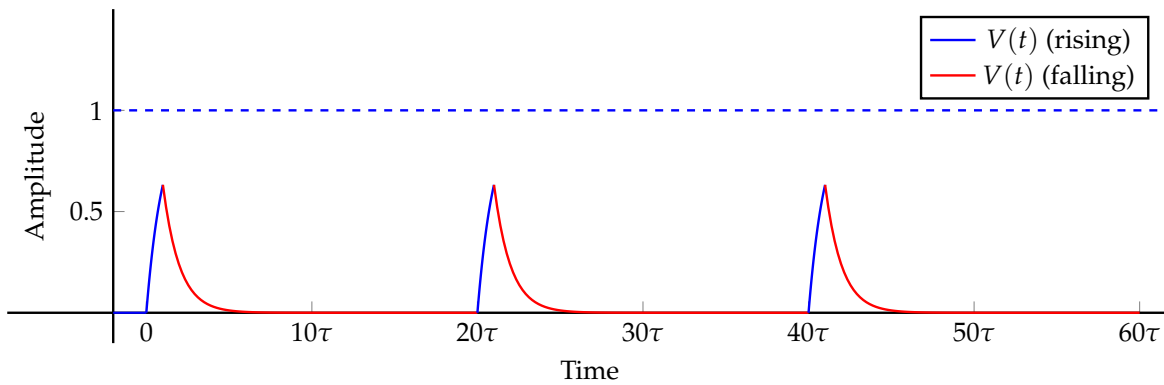

**Figure 9:** Case 2 Output: Output where only one state of the input settles

## 2.4 Case 3: The Input is Not Held Long Enough at 0 or $V_{DD}$ Long Enough to Settle.

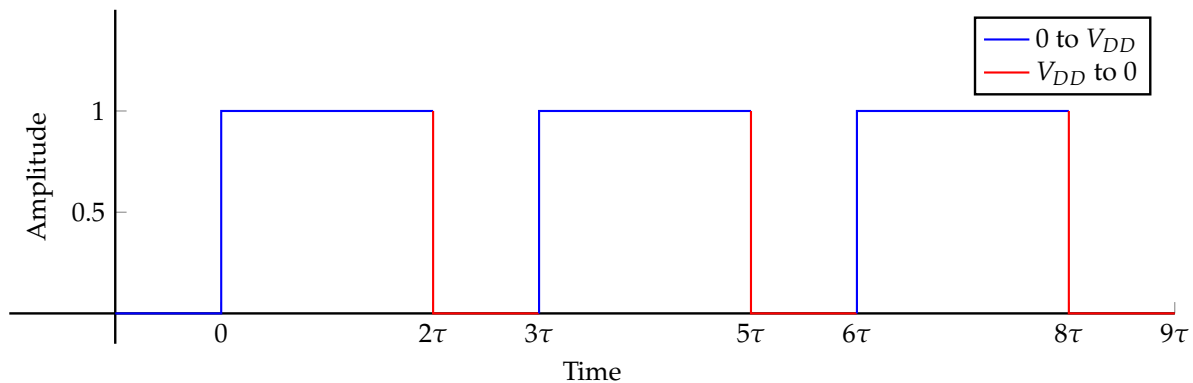

**Figure 10:** Case 3 Input: Input where both states of the input do not settle

The third case to consider is when our repeated time varying input is not at 0 or  $V_{DD}$  long enough to reach steady state for either extreme. This is illustrated in fig. 10. The output voltage is illustrated in fig. 11.

For this kind of case, we had no choice but to go interval by interval:

1. Solve the differential equation to get a function for voltage changing with time.
2. Solve for the initial condition using the previous interval's solution.
3. Plug in the initial condition to the solution of the differential equation for the current interval.

Notice that in this case, the magnitude of the voltage on the capacitor seems to have a very slight upward trajectory (the top end of the rising edge seems to go higher and higher each time).

Can we figure out what this sawtooth shape will eventually start looking like? It will stay a sawtooth, and we know that each tooth will be  $3\tau$  long. But where will the top and bottom of the teeth be? This is an interesting exercise to think about.

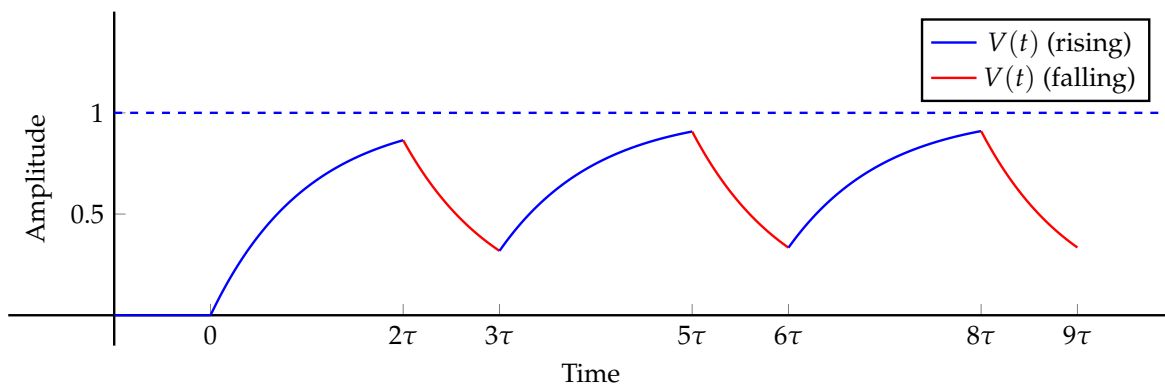

**Figure 11:** Case 3 Output: Transient voltage for repeated switch when both states of the input do not settle: Notice how the peak voltage goes gently up over time.

### 3 Building To General Inputs (Functions of Time), Not Necessarily Piecewise Constant

#### 3.1 Guessing/Deriving a Solution for General Input Functions

Now that we know how to deal with repeated transients, we want to move towards analyzing any function of  $t$ . That is, we would like to be able to deal with a differential equation of the form:

$$\frac{dV(t)}{dt} = \lambda V(t) - \lambda u(t) \quad (26)$$

where  $u(t)$  is any function of time. However, up until now, we have only dealt with piecewise constant inputs and repeated cases of these piecewise constants.

To analyze more complicated functions, we can start by approximating them as being piecewise constant over fixed interval widths  $\Delta$  — which we know how to solve from what we have seen so far. That is, we can analyze these just like repeated transients by finding new initial conditions and using those at every transition point.

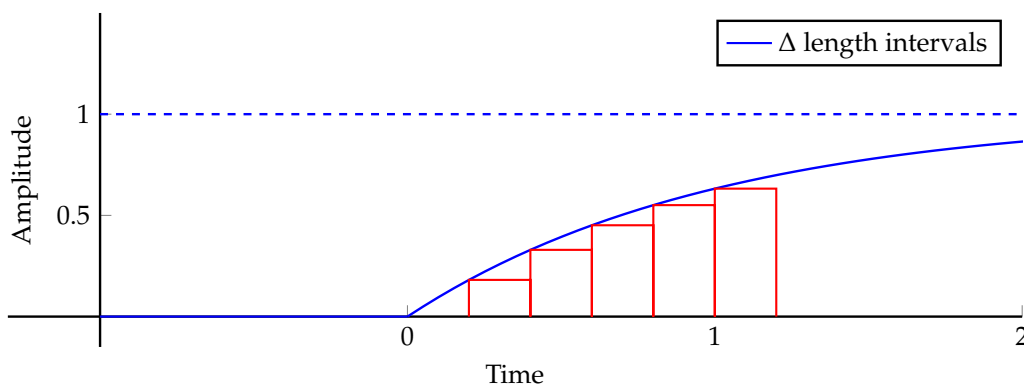

**Figure 12:** Our style of approximating a general function by something that is piecewise constant. This is akin to a Riemann sum.

Given some initial condition, let our approximated problem take the form of a differential equation with a piecewise constant input. Namely, for the  $i$ -th interval for  $t \in (i\Delta, (i+1)\Delta]$ :

$$\frac{dV(t)}{dt} = \lambda V(t) - \lambda u(i\Delta) \quad (27)$$

where  $u(i\Delta)$  is a constant value (the value of the input function  $u(t)$  at time  $t = i\Delta$ ).

This parallels  $\frac{dV(t)}{dt} = -\frac{V(t)}{RC} + \frac{V_{DD}}{RC}$  where  $\lambda = -\frac{1}{RC}$ , and where our input function is just the constant  $V_{DD}$  or 0 as we saw in the previous section.

Using what we know, we can solve the differential equation for this interval to get:

$$V(t_{\text{int}}) = ke^{\lambda t_{\text{int}}} + u(i\Delta). \quad (28)$$

where  $t_{\text{int}} = t - i\Delta$  is the time internal to this interval, and the initial condition for this interval  $v_i = k + u(i\Delta)$ . Consequently:

$$V(t_{\text{int}}) = (v_i - u(i\Delta))e^{\lambda t_{\text{int}}} + u(i\Delta). \quad (29)$$

We can use the above formulation to solve for the transients over distinct intervals of width  $\Delta$ . We can use this transient behavior to solve for the value of  $V(t)$  at the end of the  $\Delta$  long interval to get the initial



condition for the next interval, and continue the process for the rest of the input function. Using this process, we can start to approximate the solutions to differential equations of the form:

$$\frac{dV(t)}{dt} = \lambda V(t) - \lambda u(t) \quad (30)$$

where  $u(t)$  is some arbitrary input function. To proceed with this method, let us define some terms.

Let  $V_i(t)$  be the solution of the differential equation for the  $i$ -th time interval. Let  $t$  be the absolute time starting time at 0 and let  $t_{\text{int}} = t - i\Delta$  be the relative time that starts at 0 at the beginning of each interval (the  $i$  defining the  $i$ -th interval is implicit whenever we are using  $t_{\text{int}}$ ). Let  $v_i$  be the initial condition for the  $i$ -th time interval and  $u(i\Delta)$  (which is just a sample of our input function  $u(t)$  at time  $t = i\Delta$ ) be the constant input for the  $i$ -th time interval.

Consequently,  $v_i = V_{i-1}(t_{\text{int}} = \Delta)$ , and:

$$V(t) = \begin{cases} V_0(t_{\text{int}} = t) & t \in [0, \Delta] \\ V_1(t_{\text{int}} = t - \Delta) & t \in [\Delta, 2\Delta] \\ V_2(t_{\text{int}} = t - 2\Delta) & t \in [2\Delta, 3\Delta] \end{cases} \quad (31)$$

By the equations above, we have:

$$\begin{aligned} V_0(t_{\text{int}}) &= (v_0 - u(0))e^{\lambda t_{\text{int}}} + u(0) \\ V_1(t_{\text{int}}) &= (v_1 - u(\Delta))e^{\lambda t_{\text{int}}} + u(\Delta) \\ V_2(t_{\text{int}}) &= (v_2 - u(2\Delta))e^{\lambda t_{\text{int}}} + u(2\Delta) \end{aligned}$$

Since each interval is  $\Delta$  long, the initial condition for  $v_{i+1} = V_i(t_{\text{int}} = \Delta)$ . As we try to evaluate  $V(t)$  at a certain point, we have to repeat the process of finding the transient behavior, then using it to find the initial condition, and finally plugging in that initial condition to find the next transient behavior, over and over until we reach the time interval of interest. We can grind this out in a relatively mindless fashion:<sup>3</sup>

$$\begin{aligned} v_1 &= (v_0 - u(0))e^{\lambda\Delta} + u(0) \\ V_1(t_{\text{int}}) &= \left( (v_0 - u(0))e^{\lambda\Delta} + u(0) - u(\Delta) \right) e^{\lambda t_{\text{int}}} + u(\Delta) \\ v_2 &= V_1(\Delta) = \left( (v_0 - u(0))e^{\lambda\Delta} + u(0) - u(\Delta) \right) e^{\lambda\Delta} + u(\Delta) \\ V_2(t_{\text{int}}) &= \left( \left( \left( (v_0 - u(0))e^{\lambda\Delta} + u(0) - u(\Delta) \right) e^{\lambda\Delta} + u(\Delta) \right) - u(2\Delta) \right) e^{\lambda t_{\text{int}}} + u(2\Delta) \end{aligned}$$

We could keep going until  $V_3(t_{\text{int}})$ ,  $V_4(t_{\text{int}})$ , etc. but if we stop here having established a pattern, we arrive at an expression which we can simplify as follows:

$$V_2(t_{\text{int}}) = v_0 e^{\lambda(2\Delta + t_{\text{int}})} + u(0) \left( e^{\lambda(\Delta + t_{\text{int}})} - e^{\lambda(2\Delta + t_{\text{int}})} \right) + u(1\Delta) \left( e^{\lambda t_{\text{int}}} - e^{\lambda(\Delta + t_{\text{int}})} \right) + u(2\Delta) \left( 1 - e^{\lambda t_{\text{int}}} \right)$$

But as we can see, chaining through the transient effects of all these constant inputs to get to some time  $t$  can be quite annoying. Fortunately, there's a pattern to this that we can spot the pattern in the equations. Substituting  $t_{\text{int}} = t - 2\Delta$  into the equation for the 2nd interval we get:

$$V(t) = v_0 e^{\lambda t} + u(0) \left( e^{\lambda(t-\Delta)} - e^{\lambda t} \right) + u(1\Delta) \left( e^{\lambda(t-2\Delta)} - e^{\lambda(t-\Delta)} \right) + u(2\Delta) \left( 1 - e^{\lambda(t-2\Delta)} \right)$$

<sup>3</sup>Note the way the inputs end up "coupling together" recursively, such that at some later time, the inputs applied until that time all contribute to the voltage in a predictable way.

If we focus on the end of this interval  $t = 3\Delta$ , we can represent  $1 = e^{\lambda(t-3\Delta)}$ . With this substitution we can rewrite the above sum as:

$$V(t = 3\Delta) = v_0 e^{\lambda t} + u(0) \left( e^{\lambda(t-\Delta)} - e^{\lambda t} \right) + u(1\Delta) \left( e^{\lambda(t-2\Delta)} - e^{\lambda(t-\Delta)} \right) + u(2\Delta) \left( e^{\lambda(t-3\Delta)} - e^{\lambda(t-2\Delta)} \right)$$

and capture the regularity using summation notation:

$$V(t = 3\Delta) = v_0 e^{\lambda t} + \sum_{i=0}^2 u(i\Delta) \left( e^{\lambda(t-(i+1)\Delta)} - e^{\lambda(t-i\Delta)} \right) \quad (32)$$

Looking at the pattern for this sum of 3, we can extrapolate/guess this to be a sum of any  $t = n\Delta$ .

$$\begin{aligned} V(t = n\Delta) &= v_0 e^{\lambda t} + \sum_{i=0}^{n-1} u(i\Delta) \left( e^{\lambda(t-(i+1)\Delta)} - e^{\lambda(t-i\Delta)} \right) \\ &= v_0 e^{\lambda t} + \sum_{i=0}^{n-1} u(i\Delta) e^{\lambda(t-i\Delta)} \left( e^{-\lambda\Delta} - 1 \right). \end{aligned}$$

When solving for  $V(t = n\Delta)$  this way, we get an estimate of the voltage on the capacitor when the true input is not piecewise constant to begin with. But we can make this estimate better by making our  $\Delta$  decrease and get infinitesimally small. Then, for any fixed actual time  $t$ , the corresponding  $n$  would go to  $\infty$  as  $\Delta \rightarrow 0$ . Precisely, we can choose  $\Delta = \frac{t}{n}$  and then take a limit:

$$\lim_{n \rightarrow \infty} V(t) = v_0 e^{\lambda t} + \lim_{n \rightarrow \infty} \sum_{i=0}^{n-1} u(i\Delta) e^{\lambda(t-i\Delta)} \left( e^{-\lambda\Delta} - 1 \right) \quad (33)$$

This sum looks almost like a Riemann sum, except that it has  $(e^{-\lambda\Delta} - 1)$  instead of something proportional to the small  $\Delta = \frac{t}{n}$ . To simplify this, let us recall the Taylor series approximation for  $e^x$ .

$$e^x = 1 + x + \frac{x^2}{2!} + \frac{x^3}{3!} + \dots \quad (34)$$

Noticing that  $\lambda\Delta$  is small, keeping the first two terms of the exponential's Taylor expansion, and plugging this into the above equation we get:

$$\begin{aligned} \lim_{n \rightarrow \infty} V(t) &\approx v_0 e^{\lambda t} + \lim_{n \rightarrow \infty} \sum_{i=0}^n u(i\Delta) e^{\lambda(t-i\Delta)} (1 - \lambda\Delta - 1) \\ &= v_0 e^{\lambda t} + \lim_{n \rightarrow \infty} \sum_{i=0}^n u(i\Delta) e^{\lambda(t-i\Delta)} (-\lambda\Delta) \\ &= v_0 e^{\lambda t} + \lim_{\Delta \rightarrow 0} (-\lambda) \sum_{i=0}^{\frac{t}{\Delta}} u(i\Delta) e^{\lambda(t-i\Delta)} \Delta \end{aligned}$$

The summation term here reminds us of a Riemann sum from calculus, and we convert it into an integral:

$$\lim_{\Delta \rightarrow 0} \sum_{i=0}^{\frac{t}{\Delta}} u(i\Delta) e^{\lambda(t-i\Delta)} \Delta = \int_0^t u(\theta) e^{\lambda(t-\theta)} d\theta \quad (35)$$

This gives us the limiting solution:

$$V(t) = v_0 e^{\lambda t} - \lambda \int_0^t u(\theta) e^{\lambda(t-\theta)} d\theta \quad (36)$$

We made some approximations along the way, but intuitively, all of those approximations get more and more accurate as  $\Delta \rightarrow 0$ . So now have a generalized way for solving differential equations with any input

that is a function of  $t$ ! Note that in all our calculations, we did not make any assumptions about  $\lambda$ , or even the input being real. Thus our derivation is equally applicable to complex  $\lambda$  and complex inputs.

Also notice that we started off trying to solve the differential equation:

$$\frac{dV(t)}{dt} = \lambda V(t) - \lambda u(i\Delta) \quad (37)$$

This was simply to match the differential equation when solving for the voltage on the capacitor. We can use the same methods as above to derive a solution to the differential equation:

$$\frac{dx}{dt} = \lambda x(t) + u(t) \quad (38)$$

and get

$$x(t) = x_0 e^{\lambda t} + \int_0^t e^{\lambda(t-\theta)} u(\theta) d\theta \quad (39)$$

$$= x_0 e^{\lambda t} + e^{\lambda t} \int_0^t e^{-\lambda\theta} u(\theta) d\theta \quad (40)$$

If our initial condition (starting time) is actually at some  $t = t_0 \neq 0$ , we can adjust the above formula to write that (for  $t > t_0$ ):

$$x(t) = x_{t_0} e^{\lambda(t-t_0)} + e^{\lambda(t-t_0)} \int_{t_0}^t e^{-\lambda\theta} u(\theta) d\theta \quad (41)$$

## 3.2 Checking Our Solution

During the previous section's derivation, we might have seemed a little aggressive with approximations and limits. This is understandable. However, you have likely seen limits like the above in calculus, as well as approximations like the above in calculus. But the new concept is to see them both together; we need to check if our solution makes any sense and then understand if it is indeed correct.

### 3.2.1 Plug in a Known Function

In order to check our solution to the differential equation, the first thing to do is to plug in an input whose solution we already know and trust. Let us plug in a constant input that is 1 for time  $t \geq 0$ . Using our solution for  $V(t)$  we get:

$$V(t) = v_0 e^{\lambda t} + (-\lambda) \int_0^t 1 e^{\lambda(t-\theta)} d\theta \quad (42)$$

where for our capacitor circuit.  $\lambda = -\frac{1}{RC}$  and the initial condition  $v_0 = 0$ .

$$\begin{aligned} V(t) &= v_0 e^{\lambda t} + (-\lambda) \int_0^t 1 e^{\lambda(t-\theta)} d\theta \\ &= v_0 e^{-\frac{t}{RC}} + \left(\frac{1}{RC}\right) \int_0^t 1 e^{-\frac{1}{RC}(t-\theta)} d\theta \\ &= \left(\frac{1}{RC}\right) \int_0^t 1 e^{-\frac{1}{RC}(t-\theta)} d\theta \\ &= \left(\frac{1}{RC}\right) (RC) \left[ e^{-\frac{1}{RC}(t-\theta)} \right]_0^t \\ &= \left( e^{-\frac{1}{RC}(t-t)} - e^{-\frac{1}{RC}(t-0)} \right) \\ &= 1 - e^{-\frac{t}{RC}} \end{aligned}$$

This is exactly the equation for a charging capacitor:  $V(t) = V_{DD} \left(1 - e^{-\frac{t}{RC}}\right)$  where  $V_{DD} = 1$ , and this is exactly what we expect with this constant input! So this makes sense. The solution also makes sense for a zero input.

### 3.2.2 Plug into the Original Differential Equation

We can further verify this by plugging the guessed solution  $V(t) = v_0 e^{\lambda t} - \lambda \int_0^t u(\theta) e^{\lambda(t-\theta)} d\theta$  into the original differential equation:

$$\frac{dV(t)}{dt} = \lambda V(t) - \lambda u(t) \quad (43)$$

Doing so:

$$\frac{dV(t)}{dt} = \frac{d}{dt} \left[ v_0 e^{\lambda t} + (-\lambda) \int_0^t u(\theta) e^{\lambda(t-\theta)} d\theta \right] \quad (44)$$

We can then use the fundamental theorem of calculus to compute the derivative<sup>4</sup>:

$$\begin{aligned} \frac{dV(t)}{dt} &= \lambda v_0 e^{\lambda t} + (-\lambda) \left[ 1 e^{\lambda(t-t)} u(t) + \int_0^t u(\theta) \lambda e^{\lambda(t-\theta)} d\theta \right] \\ &= \lambda v_0 e^{\lambda t} + (-\lambda) \left[ u(t) + \lambda \int_0^t u(\theta) e^{\lambda(t-\theta)} d\theta \right] \\ &= \lambda \left[ v_0 e^{\lambda t} - \lambda \int_0^t u(\theta) e^{\lambda(t-\theta)} d\theta \right] - \lambda u(t). \end{aligned}$$

Notice that the expression within the square brackets is just  $V(t) = v_0 e^{\lambda t} - \lambda \int_0^t u(\theta) e^{\lambda(t-\theta)} d\theta$  and so replacing this, we get  $\frac{dV(t)}{dt} = \lambda V(t) - \lambda u(t)$ . This means our guessed solution satisfies the original differential equation!

For the initial condition,  $V(0) = v_0 e^{\lambda 0} - \lambda \int_0^0 u(\theta) e^{\lambda(t-\theta)} d\theta = v_0 e^0 + 0 = v_0$ , so that matches up as well.

Now that we have showed a solution to the differential equation, it is important to consider uniqueness. You will do this in your homework! The key trick is to consider the difference  $z(t) = x(t) - y(t)$  of two candidate solutions  $x(t)$  and  $y(t)$ . If you take the derivative  $\frac{d}{dt} z(t)$ , you will see that this must solve the differential equation  $\frac{d}{dt} z(t) = \lambda z(t)$  with no input, together with the initial condition  $z(0) = x(0) - y(0) = 0$ . Since this differential equation has a unique solution  $0e^{\lambda t} = 0$  for all  $t \geq 0$ , it must be the case that  $z(t) = 0$  and hence  $x(t) = y(t)$ . So solutions must be unique. Because we have found one, we have found the only one!

### 3.3 Trying This Out

Using the above formula, let us try it out for some interesting inputs. Assuming we have the same differential equation:  $\frac{dV(t)}{dt} = \lambda V(t) - \lambda u(t)$ , let us find an expression for  $V(t)$  when the input  $u(t) = t^k e^{\lambda t}$  for  $t \geq 0$  and some  $k > -1$  with the initial condition  $v_0 = 0$ .

Plugging into the solution above, we get:

$$V(t) = (-\lambda) \int_0^t \theta^k e^{\lambda \theta} e^{\lambda(t-\theta)} d\theta$$

<sup>4</sup>Recall that the fundamental theorem can be used to apply the derivative to the integral in a chain rule like fashion. We first take the derivative of the upper limit of the integral times the upper limit plugged into the inside of the integral. To this, we add the integral of the derivative of the inside of the integral. The latter term can be viewed as corresponding to bringing the derivative inside a summation. The first term corresponds to understanding that the number of terms essentially depends on  $t$ , and so the "last term" in the sum has to do with the derivative with respect to the upper limit of the integral. If you don't remember this, look up the Fundamental Theorem of Calculus in Leibniz form.

$$\begin{aligned} &= (-\lambda) \int_0^t \theta^k e^{\lambda t} d\theta \\ &= (-\lambda) e^{\lambda t} \int_0^t \theta^k d\theta \\ &= (-\lambda) e^{\lambda t} t^{k+1} \frac{1}{k+1}. \end{aligned}$$

This turns out to be important later, but for now, it is just an interesting example.

**Contributors:**

- Neelesh Ramachandran.
- Nikhil Shinde.
- Anant Sahai.
- Aditya Arun.